

Product Description

Captive mounts are designed with an integral overload stop, which controls the movement of equipment during transit and provides a fully failsafe arrangement suitable for both mobile and static applications.

A universal mounting, popular in a wide range of applications. Cost effective, high performance and easy to install. The rubber is used in shear / compression providing optimum performance and offers a high level of vibration reduction. The metal cap provides UV and weathering protection and protection from contaminants such as oil and fuel. The CML mount is used where stability is a focus area. Load rating from 125kg to 5000kg.

Applications

Applications include: diesel engines generator sets, pumps, compressors, vehicles, marine engines and construction plant equipment.



Type	A Ø (mm)	B (mm)	C	D1 (mm)	D2 (mm)	E (mm)	F (mm)	G (mm)
CML060	63	35	M10 - M12	76	90	110	9	2.5
CML080	77	30	M10 - M12	108	110	135	15	3
CML095	93	35	M10 - M12	122	124	144	10	2.5
CML110	106	38	M12 - M16	138	146	171	12.5	3
CML125	121	42	M12 - M16	156	158	190	13.5	3.3
CML150	155	48	M16	176	188	216	14	4
CML160	162	59	M20	-	140	170	14.5	4
CML180	180	66	M20	149	163	192	14.5	4
CML220	220	105	M24	-	180	220	17.5	6

CML160 and CML220 have round mounting holes, not slotted.

CML060
CML080
CML095
CML110
CML125
CML150

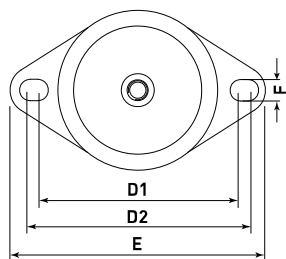

CML160
CML180
CML220

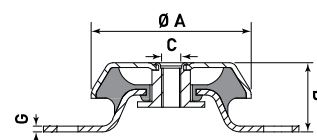
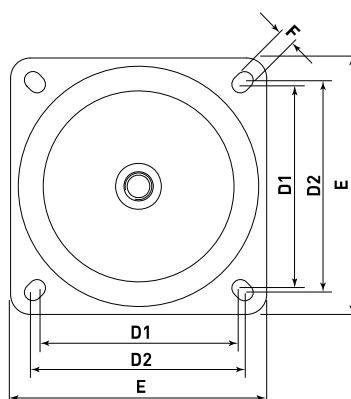

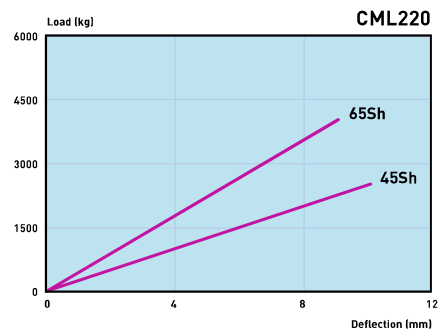
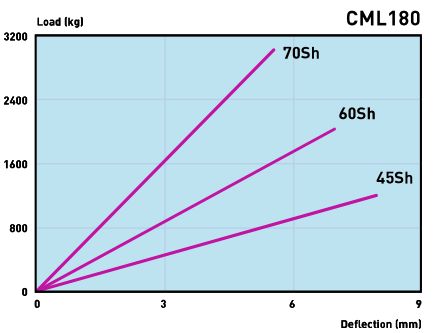
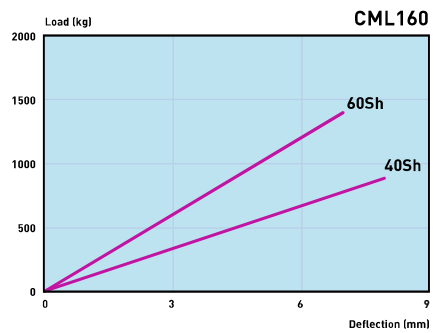
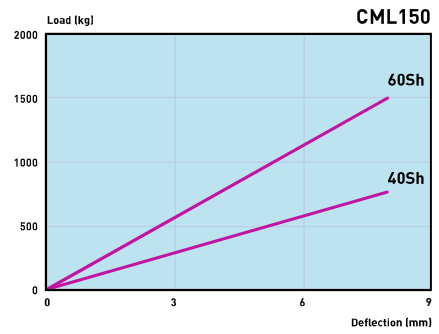
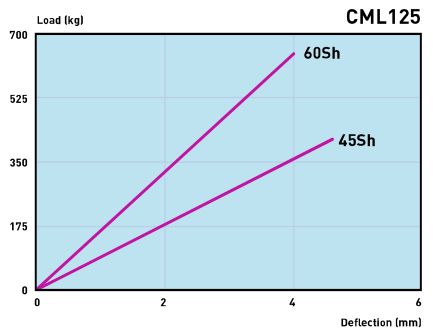
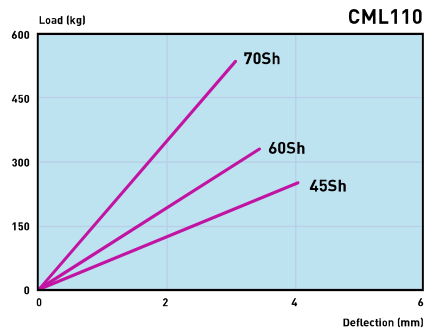
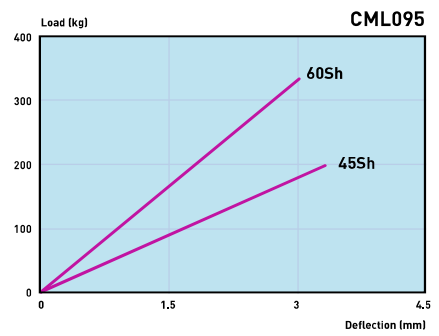
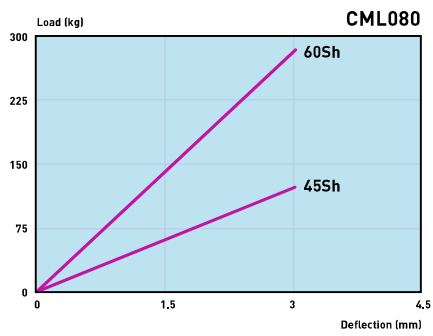
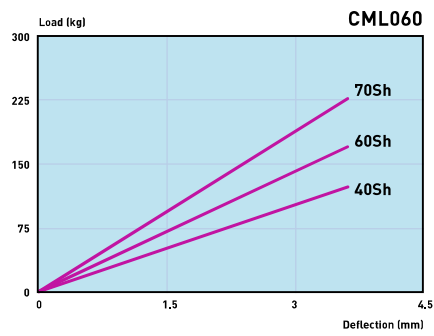

Type	40 Sh.		45 Sh.		60 Sh.		65 Sh.		70 Sh.	
	Max. load (kg)	Deflection (mm)	Max. load (kg)	Deflection (mm)	Max. load (kg)	Deflection (mm)	Max. load (kg)	Deflection (mm)	Max. load (kg)	Deflection (mm)
CML060	125	3.5	-	-	175	3.5	-	-	225	3.5
CML080	-	-	110	3.0	280	3.0	-	-	-	-
CML095	-	-	200	3.5	320	3.0	-	-	-	-
CML110	-	-	250	4.0	325	3.5	-	-	520	3.0
CML125	-	-	400	4.5	650	4.0	-	-	-	-
CML150	750	8.0	-	-	1500	8.0	-	-	-	-
CML160	900	8.0	-	-	1400	7.0	-	-	-	-
CML180	-	-	1250	8.0	2000	7.0	-	-	3000	5.5
CML220	-	-	2500	10.0	-	-	4000	9.0	5000	7.0